



T&S BRASS AND BRONZE WORKS, INC.

2 Saddleback Cove / P.O. Box 1088
Travelers Rest, SC 29690

Model No.

B-0231

Item No.

Travelers Rest, SC: 800-476-4103 • Simi Valley, CA: 800-423-0150 • Fax: 864-834-3518 • www.tsbrass.com



ADA Compliant

This Space for Architect/Engineer Approval

Job Name _____ Date _____

Model Specified _____ Quantity _____

Customer/Wholesaler _____

Contractor _____

Architect/Engineer _____

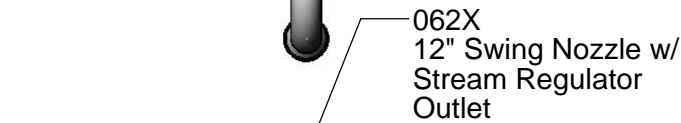
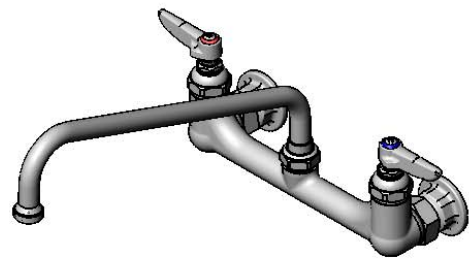
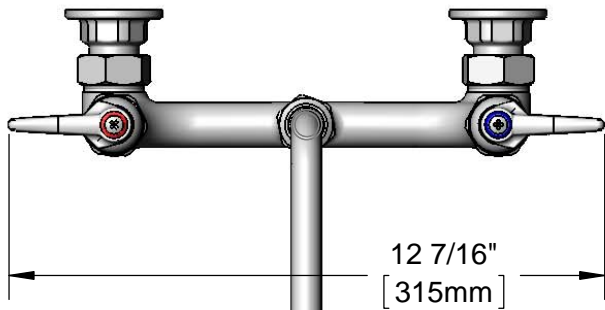

062X
12" Swing Nozzle w/
Stream Regulator
Outlet

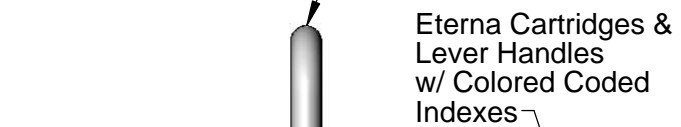

Eterna Cartridges &
Lever Handles
w/ Colored Coded
Indexes

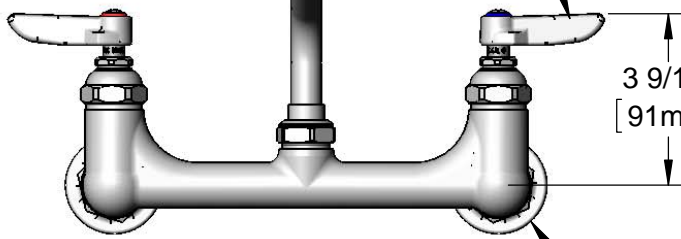

3 9/16"
[91mm]

4 3/4"
[121mm]

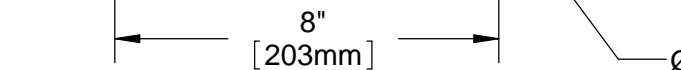

8"
[203mm]
Adjustable From
7 3/4" to 8 1/4"
[197mm to 210mm]

Ø 2" [51mm]
Flanges w/
1/2" NPT
Female Inlets

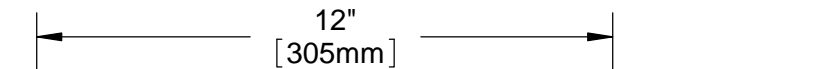

12"
[305mm]

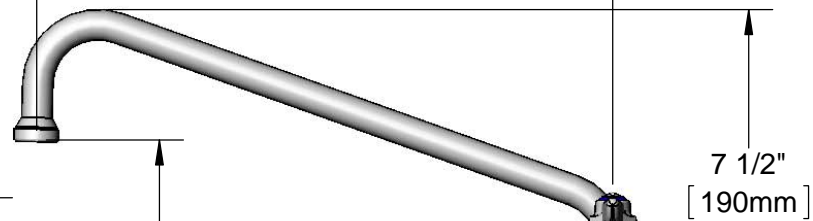

7 1/2"
[190mm]



2 3/8"
[61mm]

Mounting Surface

Product Specifications:

8" Wall Mount Mixing Faucet w/ Eterna Cartridge, Lever Handles,
12" Swing Nozzle w/ Stream Regulator Outlet & 1/2" NPT
Female Inlets

Drawn

DHL

Checked

DMH

Approved

JHB

Scale:

1:4

Date:

02/11/13



T&S BRASS AND BRONZE WORKS, INC.
 2 Saddleback Cove / P.O. Box 1088
 Travelers Rest, SC 29690

Model No.
B-0231

Item No.

Travelers Rest, SC: 800-476-4103 • Simi Valley, CA: 800-423-0150 • Fax: 864-834-3518 • www.tsbrass.com

ITEM NO.	SALES NO.	DESCRIPTION
1	062X	12" Swing Nozzle w/ B-PT Stream Regulator Outlet
2	001048-45	Nozzle Tip Washer
3	B-PT	Stream Regulator Outlet
4	001661-45	Red Index-HW
5	005960-40	Eterna Cartridges, RTC
6	009538-45	Swivel Washer
7	011429-45	Swivel Sleeves (2)
8	001074-45	O-Ring
9	000922-45	Lever Handle Screw
10	001660-45	Blue Index-CW
11	001638-45	Lever Handle
12	005959-40	Eterna Cartridges, LTC
13	00AA	1/2" NPT Female Eccentric Flange
14	001019-45	Coupling Nut Washer

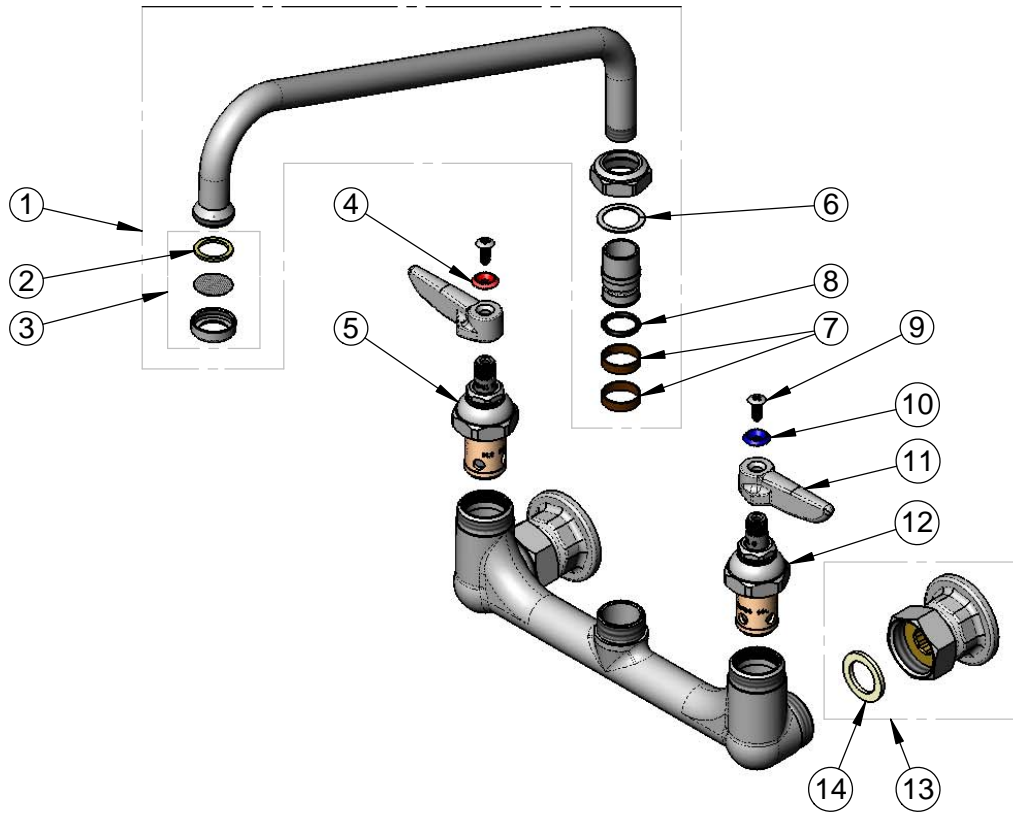

Product Specifications:
 8" Wall Mount Mixing Faucet w/ Eterna Cartridge, Lever Handles,
 12" Swing Nozzle w/ Stream Regulator Outlet & 1/2" NPT
 Female Inlets

Drawn DHL	Checked DMH	Approved JHB
Scale: NTS		Date: 02/11/13